

## 2-Door Expansion Module CA-A470-A Instruction Manual

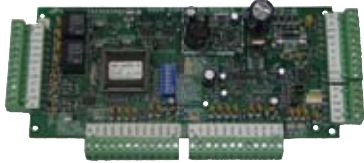

### Introduction

Connected to the CT-V900 controller's expansion bus, Maximum 3 per controller, the 2-Door Expansion Module (CA-A470-A) supports two readers, two BCD keypads, four zone inputs, 6 outputs and two locking devices.

### Specifications

**Readers:** connect 2 per module  
**Keypads:** connect 2 per module  
**Inputs:** 4 standard without ATZ, 1 tamper  
**Outputs:** 6 (open collector) 25 mA Sink  
**Lock Outputs:** 2 lock outputs (Form C relays) each: 15A @ 28VDC (resistive)  
**AC Power:** 16VAC, 40VA max.  
**Frequency:** 50Hz/60Hz  
**Aux. Current:** 500mA (max.)  
**Battery:** 12VDC, 7Ah  
 low battery = 10.2VDC  
 low battery restore = 12.2VDC  
 low battery cut-off = 8.5VDC  
**Communication:** expansion bus (E-Bus), RS-485, Plug and Play, 3 modules per CT-V900-A  
**Operating temp.:** 5°C to 55°C (41°F to 133°F)

### DIP Switches

In order for new DIP switch settings to take effect, the 2-Door Expansion Module's power must be disconnected and then reconnected.

### Assign Address (1 and 2)

DIP switches 1 and 2 determine the 2-Door Expansion Module's address in the network, regardless of the order that they are connected to the controller. Centaur recognizes the doors according to the DIP switch settings as shown in Figure 1.

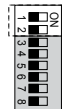
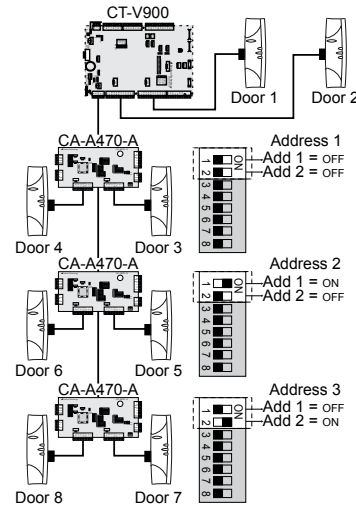
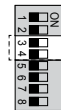

Figure 1: Setting the network address



### Lock State during Communication Failure

DIP switches 3 and 4 determine the state of Lock #1 and Lock #2 ONLY during a communication failure between the 2-Door Expansion Module and the controller (CT-V900-A). Normally, the lock outputs follow the Lock Control for the CT-V900-A. Therefore, the DIP switches should have the same setting as the Lock Control for the corresponding doors in Centaur.



Lock #1 = DIP switch 3	
Lock #2 = DIP switch 4	
<b>OFF =</b>	De-energized: During a communication failure, the normal state of the lock output is De-energized. When Lock #1 or Lock #2 is activated, power is <b>applied</b> to the corresponding lock output to unlock the door. Activation depends on the setting of the DIP switches 5 & 6 (Access during Communication Failure).
<b>ON =</b>	Energized: During a communication failure, the normal state of the lock output is Energized. When Lock #1 or Lock #2 is activated, power is <b>removed</b> from the corresponding lock output to unlock the door. Activation depends on the setting of the DIP switches 5 & 6 (Access during Communication Failure).



**De-energized:** no power in normal state; requires power to activate.

**Energized:** power in normal state; remove power to activate.

### Access during Communication Failure (5 and 6)

DIP switches 5 and 6 determine the access to the protected doors during a communication failure.

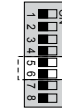

Switch	Setting	During a Communication Failure:
5	NO	"No Card" Access is denied to all cards and doors are locked until communication is restored.
6	NO	
5	NO	"2 Cards" Access is granted only when 2 cards of a valid format are presented to the reader.
6	NO	
5	NO	"All Cards" Access is granted when any card with a valid format is presented to the reader.
6	NO	
5	NO	"Unlock Door" Doors are unlocked until communication is restored.
6	NO	

### Activate Output on Communication Failure (7)

DIP switch 7 determines if OUT5 and OUT6 will pulse during a communication failure. When DIP switch 7 placed in the "ON" position, the outputs on the device(s) connected to the OUT5 and OUT6 terminals will pulse. For example, the buzzer on the reader can pulse to advise users that a communication failure has occurred.

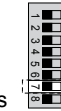

### DIP Switch (8)

For future use.

### EOL Jumper

Place the EOL jumper ON if the 2-Door Expansion Module is at the beginning (Start Point) or at the end (End Point) of the E-bus Network (see Figure 2). Otherwise, place the EOL jumper OFF.

Figure 2: Setting the Jumpers

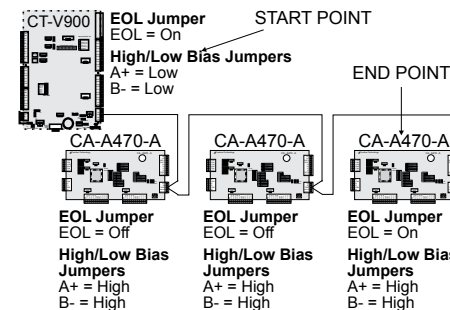

### High/Low Bias Jumpers

Place the A+ and B- jumpers on LOW only if the 2-Door Expansion Module is at the beginning (Start Point) of the E-bus Network. Otherwise, place the A+ and B- jumpers on HIGH (see Figure 2 and Figure 3).

Figure 3: Setting the A+ and B- jumpers

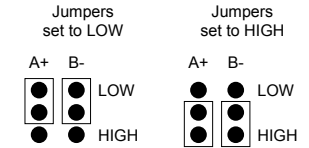

### 350mA/700mA Battery Charging Jumper

The 350mA/700mA Jumper allows you to select the charging current for the backup battery of the 2-Door Expansion Module. Charging the battery at 350mA takes longer, but consumes less power. Charging the battery at 700mA takes less time, but consumes more power.

Figure 4: Setting the 350mA/700mA jumper

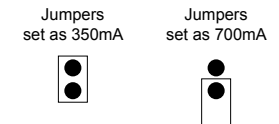

### Programming in Centaur

Using the Centaur Access Control Software, program the inputs, outputs, readers, and keypads connected to the 2-Door Expansion Module. The options are explained in the *Centaur Access Control Software Reference Manual*. Centaur will identify the 2-Door Expansion Module by its address, DIP Switches 1 & 2, and will recognize the devices as follows:

	Address 1	Address 2	Address 3
<b>Doors</b>			
Keypad/Reader 1	Door 3	Door 5	Door 7
Keypad/Reader 2	Door 4	Door 6	Door 8
<b>Inputs</b>			
Z1	Input 17	Input 21	Input 25
Z2	Input 18	Input 22	Input 26
Z3	Input 19	Input 23	Input 27
Z4	Input 20	Input 24	Input 28
<b>Outputs</b>			
OUT1	Output 7	Output 13	Output 19
OUT2	Output 8	Output 14	Output 20
OUT3	Output 9	Output 15	Output 21
OUT4	Output 10	Output 16	Output 22
OUT5	Output 11	Output 17	Output 23
OUT6	Output 12	Output 18	Output 24



Doors cannot be defined as **Door Type Elevator (Door Properties window, General tab, Door Type: Elevator)** and the module does not support Interlock Inputs (**Door Properties window, Inputs and Outputs tab, Interlock Input**).

Other modules in the system cannot activate the 2-Door Expansion Module's outputs.

The 2-Door Expansion Module does not support Zone Doubling (see Figure 6).



**CDV Group**  
**TECHNICAL SUPPORT**  
**CDV Americas**  
 Tel: (450) 682-7945 • Toll free: (866) 610-0102  
 Ext: 223  
 www.cdvamericas.com

**Figure 5: CA-A470-A indicators**

Green "AC OK" LED:  
 ON = AC power  
 OFF = Power failure

Green "AUX OK" LED:  
 ON = Auxiliary power  
 OFF = Auxiliary power failure

Red "COMM" LED:  
 ON = Communication failure  
 OFF = OK

Green "CHECK BATT" LED:  
 ON = Battery verification in progress (every minute)

Red "BATT TRBL" LED:  
 ON = Battery low or disconnected

Green "STATUS" LED:  
 Flash = Module OK  
 Slow flash = Communication failure  
 (see also "comm" LED)

Green "lock#1" and "lock #2" LEDs:  
 ON = Relay activated.

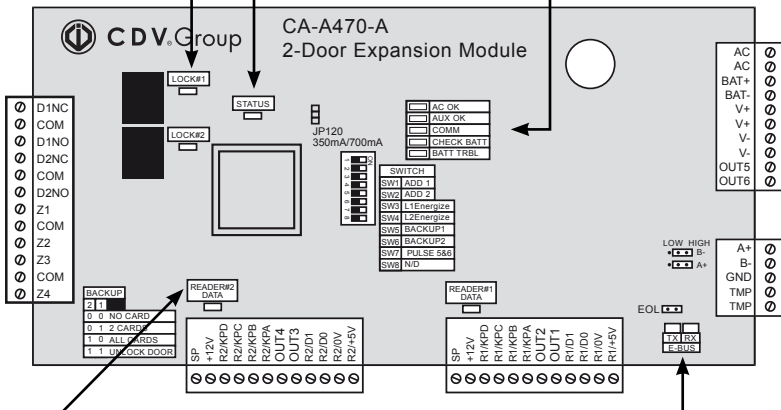

Green "reader#2 data" and "reader#1 data" LED:  
 Long flash = Receiving card read  
 Short flash = Receiving card read, but the system does not recognize the card's format  
 OFF = Not receiving card read

Red "tx" LED and green "rx" LED:  
 ON = Communication OK (may flicker)  
 OFF = Communication failure



The reader LEDs can be used to verify the reader's connections and programming. If no flashing occurs when a card is presented to the reader, the reader may be installed incorrectly. A short flash indicates that the reader is correctly installed, but the card is the wrong type or that the reader was incorrectly programmed.

**Warranty**

CDV Group ("Seller") warrants its products to be free from defects in materials and workmanship under normal use for a period of one year. Except as specifically stated herein, all express or implied warranties whatsoever, statutory or otherwise, including without limitation, any implied warranty of merchantability and fitness for a particular purpose, are expressly excluded. Because Seller does not install or connect the products and because the products may be used in conjunction with products not manufactured by Seller, Seller cannot guarantee the performance of the security system and shall not be responsible for circumstances resulting from the product's inability to operate. Seller obligation and liability under this warranty is expressly limited to repairing or replacing, at Seller's option, any product not meeting the specifications. Returns must include proof of purchase and be within the warranty period. In no event shall the Seller be liable to the buyer or any other person for any loss or damages whether direct or indirect or consequential or incidental, including without limitation, any damages for lost profits stolen goods, or claims by any other party, caused by defective goods or otherwise arising from the improper, incorrect or otherwise faulty installation or use of the merchandise sold.

Notwithstanding the preceding paragraph, the Seller's maximum liability will be strictly limited to the purchase price of the defective product. Your use of this product signifies your acceptance of this warranty.

BEWARE: Dealers, installers and/or others selling the product are not authorized to modify this warranty or make additional warranties that are binding on the Seller.

© 2001-2007 CDV Group. All rights reserved. Specifications may change without prior notice.

Centaur is a trademark or registered trademark of CDV Group, or its affiliates in Canada, the United States and/or other countries.

Specifications may change without prior notice. Printed in Canada - 20/01/07 - CA-A360-A\_1E

**Figure 6: Connection drawing of the CA-A470-A**

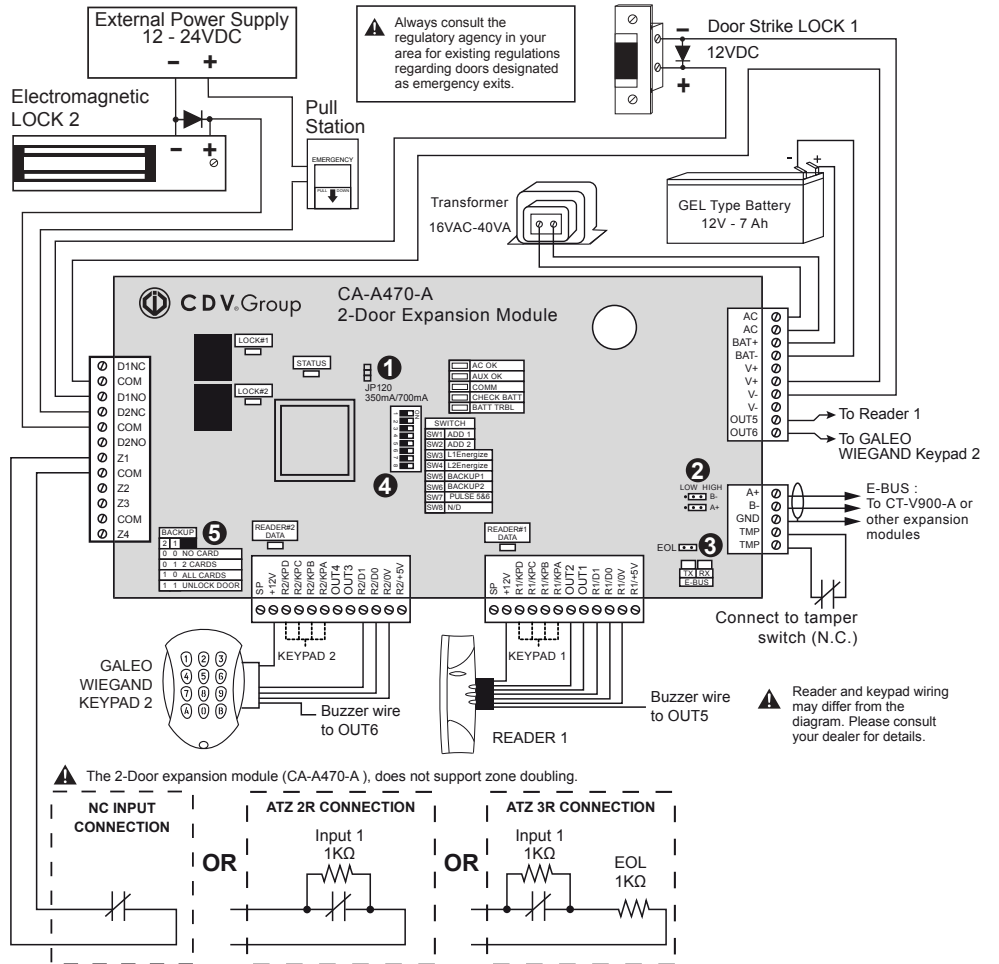

The 2-Door expansion module (CA-A470-A), does not support zone doubling.

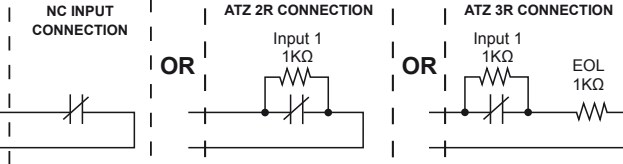

**JUMPER SETTINGS**

- BATTERY CHARGING**  
 Charging the battery at 350mA (jumper ON) takes longer, but consumes less power. Charging the battery at 700mA (jumper OFF) takes less time, but consumes more power.
- HIGH/LOW BIAS**  
 Place the A+ and B- jumpers on LOW only if the 2-Door Expansion Module is at the beginning (Start Point) of the E-bus Network. Otherwise, place the A+ and B- jumpers on HIGH.
- EOL**  
 Place the EOL jumper ON if the 2-Door Expansion Module is at the Start Point or at the End Point of the E-bus Network. Otherwise, place the EOL jumper OFF.

**DIP SWITCH SETTINGS**

